

# Husky Series



10,000 lb. / 4536 kg  
11,500 lb. / 5216 kg Stall

**2404** 12VDC

**Specifications:**  
Motor: 2.1 hp 12VDC Series Wound  
Wire Rope: 3/8" x 90' (10mm x 27.4m)  
• Power In and Power Out  
• Freespooling  
• Remote Mountable Solenoid Station with 12' Handheld Remote Switch  
Shown With Optional Roller Fairlead

**Husky 10**



8,500 lb. / 3856 kg.  
9,200 lb. / 4173 kg. Stall

**2401** 12VDC

**Specifications:**  
Motor: 2.1 hp 12VDC Series Wound  
Wire Rope: 5/16" x 150' (7.9mm x 45.6m)  
• Power In and Power Out  
• Freespooling  
• Remote Mountable Solenoid Station with 12' Handheld Remote Switch  
Shown With Optional Roller Fairlead

**Husky 8**

# X Series

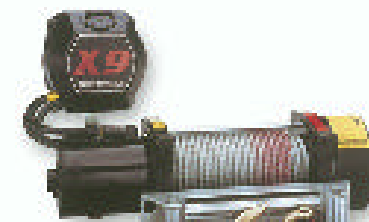

9,000 lb. / 4082 kg  
11,900 lb. / 5398 kg Stall

**1901** 12VDC

**Specifications:**  
Motor: 2.0 hp 12VDC Series Wound  
Wire Rope: 5/16" x 100' (7.9mm x 30.5m)  
• Power In and Power Out  
• Remote Mountable Solenoid Station with 12' Handheld Remote Switch  
• Freespooling  
• Automatic In-The-Drum Braking  
Shown With Optional Roller Fairlead

**X9**



6,000 lb. / 2722 kg  
6,600 lb. / 2994 kg Stall

**1646** 12VDC

**Specifications:**  
Motor: 1.6 hp 12VDC  
Wire Rope: 5/16" x 100' (7.9mm x 30.5m)  
• Power In and Power Out  
• Remote Mountable Solenoid Station with 12' Handheld Remote Switch  
• Freespooling  
• Automatic In-The-Drum Braking  
Shown With Optional Roller Fairlead

**X6CD**

Winches are not intended for the transportation of people.

# S Series



9,000 lb. / 4082 kg  
11,900 lb. / 5398 kg Stall

**1916** 12VDC Without Roller Fairlead

**1917** 12VDC With Roller Fairlead  
**Specifications:**  
Motor: 2.0 hp 12VDC Series Wound  
Wire Rope: 5/16" x 100' (7.9mm x 30.5m)  
• Power In and Power Out  
• Freespooling  
• Integrated Prewired Solenoid System with 12' Handheld Remote Switch  
• Automatic In-The-Drum Braking

**S9000**



6,000 lb. / 2722 kg  
6,600 lb. / 2994 kg Stall

**1679** 12VDC Without Roller Fairlead

**1680** 12VDC With Roller Fairlead  
**Specifications:**  
Motor: 1.6 hp 12VDC  
Wire Rope: 5/16" x 100' (7.9mm x 30.5m)  
• Power In and Power Out  
• Freespooling  
• Integrated Prewired Solenoid System with 12' Handheld Remote Switch  
• Automatic In-The-Drum Braking

**S6000**

## Winch selection guide for car and boat trailers

### CAR TRAILERS/ROLLING WEIGHT

Model	Grade*			
	20%	30%	50%	70%
EX1, T1500	3,400	2,600	1,850	1,550 lbs.
ATV2000, X1, X1F 5,100	3,900	2,800	2,300	2,300 lbs.
X2, X2F, S2500	8,503	6,527	4,655	3,817 lbs.
X3, X3F, S3500	11,905	9,138	6,518	5,344 lbs.
S4500	15,300	11,750	8,300	6,870 lbs.

\* A 10% grade is a rise of one foot in ten feet.  
\* Winches are not intended as a load securing device.

### BOAT TRAILERS

Model	Boat Length	Weight Lbs.
EX1, T1500	Outboards to 17' (5.2 m)	2,500 (1,134)
ATV2000, X1, S2500	Outboards to 18' (5.5 m)	3,500 (1,588)
X2, X2F, S3500	Outboards, I/O's to 22' (6.7 m)	6,000 (2,722)
X3, X3F, S3500	Over 22' (6.7 m)	9,300 (4,218)
S4500	Over 22' (6.7 m)	11,500 (5,216)

\* Winches are not intended as a load securing device.

In some cases, winches with 50' of rope will not achieve these loads. This is because the extra layers of rope make a turning diameter that is too large. On EX1, X1, S2500, S3500, and S4500 the grub screw in the drum can be loosened, the excess rope pulled through the drum and cut, and the screw re-tightened. On X2, X3, a shorter wire rope assembly can be fitted.  
All ratings are for bottom layer of wire rope.

Winches are not intended for the transportation of people.

# S Series



**S Series Loaded with standard features**



4,500 lb. / 2041 kg  
5,100 lb. / 2313 kg Stall

**04512** 12VDC With Hawse Fairlead

**04532** 12VDC With Roller Fairlead  
**Specifications:**  
Motor: 1.6 hp 12VDC  
Wire Rope: 1/4" x 50' (6.4mm x 15.2m)  
• Power In and Power Out  
• Freespooling  
• Wire Rope Tensioning Plate  
• Hawse Fairlead  
• Integrated Prewired Solenoid System with 12' Handheld Remote Switch

**S4500**

3,500 lb. / 1588 kg  
4,100 lb. / 1860 kg Stall

**03500** 12VDC Winch Mounted Switch and Hawse Fairlead

**03502** 12VDC Winch Mounted Switch, Hawse Fairlead and Brake



† **03512** 12VDC Remote Handheld Switch, Hawse Fairlead and Brake

† **03532** 12VDC Remote Handheld Switch and Roller Fairlead and Brake

**Specifications:**  
Motor: 1.3 hp 12VDC  
Wire Rope: 7/32" x 50' (5.6mm x 15.2m)  
• Power In and Power Out  
• Freespooling  
• Wire Rope Tensioning Plate  
• Hawse Fairlead  
† Integrated Prewired Solenoid System with 12' Handheld Remote Switch

**S3500**

2,500 lb. / 1134 kg  
3,100 lb. / 1406 kg Stall

**02500** 12VDC Winch Mounted Switch and Hawse Fairlead

**02502** 12VDC Winch Mounted Switch, Hawse Fairlead and Brake

† **02512** 12VDC Remote Handheld Switch, Hawse Fairlead and Brake

† **02532** 12VDC Remote Handheld Switch, Roller Fairlead and Brake

**Specifications:**  
Motor: 0.7 hp 12VDC  
Wire Rope: 3/16" x 50' (4.7mm x 15.2m)  
• Power In and Power Out  
• Freespooling  
• Wire Rope Tensioning Plate  
• Hawse Fairlead  
† Integrated Prewired Solenoid System with 12' Handheld Remote Switch

**S2500**

Winches are not intended for the transportation of people.

# X Series

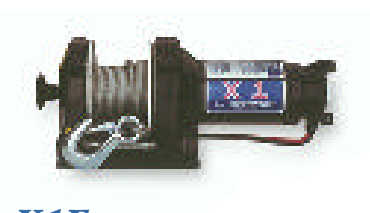

**X1F**

2,000 lb. / 907 kg  
2,500 lb. / 1,134 kg Stall

**1141** 12VDC With Winch Mounted Switch and Freespooling

**1181** 12VDC With Winch Mounted Switch and Freespooling

**Specifications:**  
Motor: 1.3 hp 12VDC  
1141 Wire Rope: 3/16" x 25' (4.7mm x 7.62m)  
1181 Wire Rope: 3/16" x 50' (4.7mm x 15.2m)  
• Power In and Power Out  
• Winch Mounted Switch  
• Freespooling  
• Wire Rope Tensioning Plate  
• Power Leads with Terminals  
• Circuit Breaker



**X1**

**1101** 12VDC With Winch Mounted Switch

**Specifications:**  
Motor: 1.3 hp 12VDC  
Wire Rope: 3/16" x 25' (4.7mm x 7.62m)  
• Power In and Power Out  
• Winch Mounted Switch  
• Power Leads with Terminals  
• Circuit Breaker

1,000 lb. / 454 kg  
1,350 lb. / 612 kg Stall

**1110** 12VDC With Winch Mounted Switch

**Specifications:**  
Motor: 0.6 hp 12VDC  
Wire Rope: 5/32" x 25' (4mm x 7.62m)  
• Power In and Power Out  
• Winch Mounted Switch  
• Power Leads with Terminals  
• Circuit Breaker

**EX1**

# Utility Winches



**T1500**  
1,500 lb. / 680 kg  
1,950 lb. / 885 kg Stall

**T1500 Specifications:**  
Motor: 45 hp  
Wire Rope: 5/32" x 25' (4mm x 7.62m)

**ATV2000 Specifications:**  
Motor: 45 hp  
Wire Rope: 5/32" x 50' (4mm x 15.2m)

**T1500 and ATV2000 Standard Features**  
• Power In and Power Out  
• Freespooling  
• Power Leads with Terminals  
• Circuit Breaker  
• Remote Mounted Switch  
• Wire Rope Tensioning Plate

Winches are not intended for the transportation of people.

# AC Winches

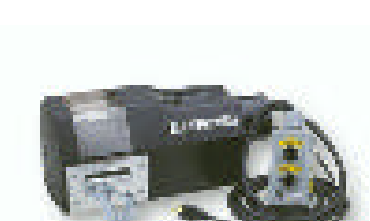

**SAC1000**

1,000 lb. / 454 kg  
2,400 lb. / 1089 kg Stall

**01002** 120V 50/60Hz Without Freespooling

**01052** 240V 50/60Hz Without Freespooling

**Specifications:**  
Motor: 5 hp  
Wire Rope: 3/16" x 50' (4.7mm x 15.2m)  
• Power In and Power Out  
• Wire Rope Tensioning Plate  
• Operates on House Current  
• 6' (1.82m) Pendant Switch  
• Circuit Breaker  
• Wire Rope Tensioning Plate

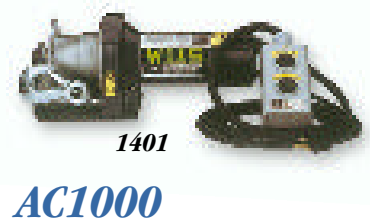

**AC1000**

1,000 lb. / 454 kg  
1,500 lb. / 680 kg Stall

**1401** 120V 50/60Hz

**1499** 240V 50/60Hz  
**Specifications:**  
Motor: 6 hp  
Wire Rope: 3/32" x 45' (4mm x 13.7m)  
• Power In and Power Out  
• 6' (1.82m) Pendant Switch  
• Operates on House Current  
• Circuit Breaker  
• Wire Rope Tensioning Plate

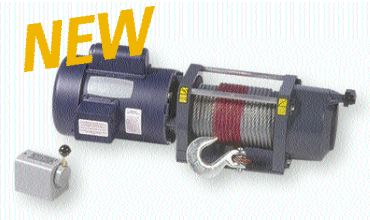

**AC2000**

2,000 lb. / 907 kg  
1723 115/208-230V 60Hz single phase With Switch and Wire Rope

1723A 115/208-230V 50Hz single phase With Switch and Wire Rope

**Specifications:**  
Motor: 1 hp Capacitor Start TEFC  
Wire Rope: 1723 5/16" x 100' (7.9mm x 30.5m)  
• Power In and Power Out  
• Automatic Mechanical Brake  
• 11 FPM  
• 15 Minutes "On Time" at Full Load  
• Freespooling

# Windlass/Capstan



**EC600**

600 lb. / 272 kg  
1,000 lb. / 454 kg Stall

**1452 EC600 12VDC**

**Specifications:**  
Motor: 1.3 hp 12VDC  
• Complete with Foot Switch  
• Permanently Lubricated Gearbox  
• Polyurethane Over Epoxy Finish  
• For Anchor Handling on Boats to 40' (12m)

Winches are not intended for the transportation of people.

# Premium Hubs

## Premium 4WD Hubs For Domestic and Import Vehicles

Corrosion Resistant Painted and Polished Aluminum Finishes



Full Metal Cap and Body, 1/2 Turn from 2WD to 4WD



- **Premium classic design and durability...** full metal cap and body
- **Better fuel economy...** because there's less drag on your engine.
- **More miles from your front tires ...** since they rotate freely. Also allows you to steer more freely in turns.
- **More power and performance ...** since front drivetrain isn't rotating; engine has reduced load.
- **More comfortable ride ...** steering is lighter, and there is less tendency to shimmy; drivetrain noise and vibration are also reduced.
- **Better 4WD ...** performance when the hubs are locked. Works in reverse and compression braking. No slippage or partial engagement/disengagement problems.

## 4 x 2 Conversion Kits

Convert "New Process" 203 full-time transfer case to part time 4WD/2WD.

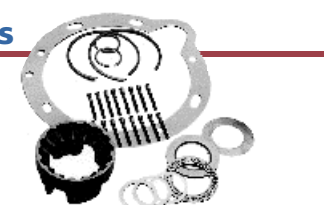

Part	Application
900801	Conversion Kit only (hubs not included)
900802	900801 plus Superhub set 400518, 1/2 ton hubs, Chevy/GMC truck, Blazer/Jimmy, Ford F100/150, Bronco, F250 with 3,000 and 3,500 lbs. axle.
900803	900801 plus Superhub set 400517, 3/4 ton hubs, Chevy/GMC 3/4 ton, Ford F250 with 3,500 axle 1963 - 1977
900805	900801 plus Superhub set 400439, 1 ton hubs, Chevy/GMC K30 1ton '78 - present, Ford F250/Crew Cab W/3800 axle, Ford F350 1 ton W/4500 axle..

Winches are not intended for the transportation of people.

# Mounting Kits

# NEW SuperMount System

## ATV Mount Kits **NEW**



Mounts come complete with roller fairlead

ARCTIC CAT P/N	Model	POLARIS P/N	Model
2350	BEAR CAT 454 4X4, 1996-98 300 4X4, 1998	2355	TRAIL BOSS 250, 1994-95 300 2X4 AND 4X4, 1994-95 BIG BOSS 6X6 300, 1994
<b>HONDA P/N</b>	<b>Model</b>	2356	250L 2X4 AND 4X4, 1991-93 400L 2X4 AND 4X4, 1994 400L SPORTSMAN 4X4, 1994-97 425 MAGNUM 2X4 AND 4X4, 1995-98 425 MAGNUM 6X6, 1996-97 BIG BOSS 400L 6X6, 1996-97
2351	TRX400 FOREMAN 1995-98	2357	300 XPLORER 4X4, 1996-98 400L XPLORER 4X4, 1995-98 SPORTSMAN 500 4X4, 1996-98 XPLORER 500 4X4, 1997
2352	TRX300 2X4 AND 4X4, 1993-98	<b>YAMAHA P/N</b>	<b>Model</b>
<b>KAWASAKI P/N</b>	<b>Model</b>	2359	YFM 250 TIMBERWOLF, 1992-97 TIMBERWOLF 4X4, 1994-97
2353	KLF 300 BAYOU, 1988-95 *NO ROLLER FAIRLEAD	2360	YFM 350 FW BIG BEAR, 1987-96 YFM 350 2WD BIG BEAR, 1996-97
2354	PRAIRIE, 1997-98	2361	YFM 400 KODIAK, 1993-97 YFM 350 FW BIG BEAR SE, 1997
2363	KLF 400 4X4, 1992-96	2362	BIG BEAR 4X4, 1997
2364	KLF 300 4X4, 1989-98	2365	YFM 350 FX WOLVERINE, 1995-97
2368	KLF 300 BAYOU, 1997-98	2366	GRIZZLY 600 1998
<b>SUZUKI P/N</b>	<b>Model</b>	2367	BIG BEAR, 1997-98
2358	LT 250, 1989-97 LT 4WD, 1987-97 LT KING QUAD, 1991-97		

## Put up a good front.

Superwinch grill guards are rugged and resilient, they'll enhance the looks of your vehicle while expanding your driving freedom. Superwinch grill guards for full size vehicles accept all models including Husky. Our grill guards create the reliable up-front answer to today's challenges of *real* off road.



## Grill Guards

- Economical and easily fits most pickups and 4WD vehicles
- Easy to install
- Fits over original equipment bumper
- Accepts all Superwinch models

## Jeep Mounting Kits

- Fits CJ, YJ and TJ models
- Incorporates original bumper, mounting plate and hardware
- Low cost and easily installed
- Accepts most Superwinch models



**We make it easy.** The system contains two receivers, a bracket kit, and winch cradle. Simply place the cradle on top of the brackets, align two holes, and pin. Now your winch is ready to roll.

When conditions call for rear winching, SuperMount quickly plugs into any standard 2" Class III receiver hitch using a simple adapter. Such versatility isn't just nice, it's essential when front and rear mounting options are the only thing between you and being stuck.

**We make it strong.** Where you're headed, power counts. That's why SuperMount's heavy duty custom winch mounting system has not one but two receivers. These dual receivers are painstakingly crafted in the USA to strict standards of quality in materials and performance. They're constructed of high strength steel and securely fastened with two corrosion resistant steel locking pins.

Mounted from the front of your vehicle, SuperMount securely handles 9,000 lbs. of pull for effective, twist-free action. Mounted from the rear, the system will withstand pulls of up to 4,500 lbs. or maximum hitch rating. Add a pulley block and double line back to your vehicle frame to maximize your pulling capacity. Great for use on on pickups, trucks, vans, RVs. and cars.

Part	Description
2000	Winch Cradle
2001	Rear Receiver Adapter
2002	Receiver and Shackle Bracket

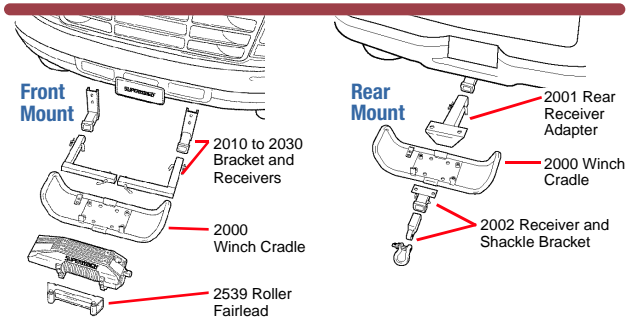

**TREAD LIGHTLY!** OFFICIAL SPONSOR  
ON PUBLIC AND PRIVATE LAND

Superwinch encourages you to help preserve our national forests and other public and private lands by "Treading Lightly".

"Tread Lightly" is an education program designed to increase public awareness of land-use regulations and responsibilities in our wilderness areas.

Distributed By:



Superwinch, Inc.  
Winch Drive  
Putnam, Connecticut 06260 U.S.A.  
Telephone: (860) 928-7787  
FAX: (860) 928-1143  
e-mail: info@superwinch.com  
www.superwinch.com/

Design, materials and specifications are subject to change without notice. Superwinch Inc. is not responsible for printing errors inadvertently made in the production of this catalog.

## The World's Most Popular Electric Winch



# Replacement Switches and Accessories



**2233** ATV Mountable Rocker Switch Fits T1500 and ATV2000 Only



**1519** Replacement Switch Fits EX1, X1, and X2 Series Winches

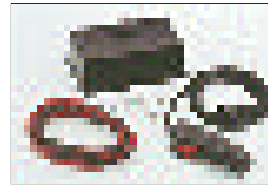

**1515A** Handheld Remote Switch 12 and Solenoid Kit Fits EX1, X1, X2, S2500, S3500



**1520** Trailer Wiring Kit Fits EX1, X1, X2, X3, S2500, S3500 and S4500 Series Winches

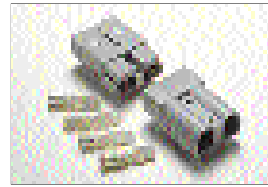

**1551** Quick Connect Permits quick and safe connections for both negative and positive electric power cables

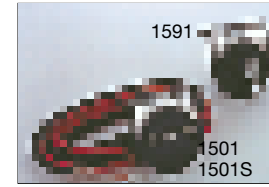

**1591** Three Position Heavy Duty Rotary Switch Fits EX1, X1, X2, S2500, S3500  
**1501** Dash Mount Kit Fits EX1, X1, X2  
**1501S** Dash Mount Kit Fits S2500 and S3500

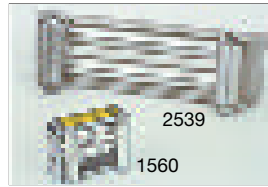

**Roller Fairleads**  
**2539** Fits X6CD, X9, S9000, S6000, and Husky winches  
**1560** Fits EX1, X1, X2, and X3



**Roller Fairlead Cover**  
**2543** Fits Roller Fairlead 2539

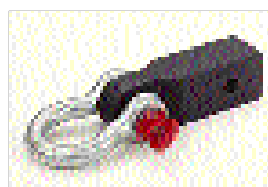

**Receiver Shackle Bracket**  
**2546** Fits all standard class III receiver hitches



**Portable Winch Mounts**  
**1559A** Class II Receiver Hitch Mount

# Pulley Blocks, Roller Fairleads and Off-Road Accessories

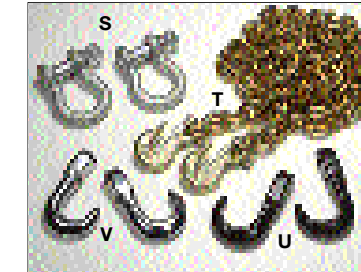

**S 2538** Bow Shackles (Pair)  
**T 2541** Chain With Grab Hooks Chain is 3/8" x 10'  
**U 1510** Black Tow Hooks (Pair)  
**V 1578** Chrome Tow Hooks (Pair)



**Accessory Kits**  
All Kits Contain the Following:  
• Nylon Carry Bag  
• Heavy Duty Leather Palmed Gloves

**The Following Also Contain:**  
**Kit 2224** • Heavy Duty Pulley Block 20,000 lbs. (2223)  
• Nylon Sling (2531)  
• 2 Bow Shackles (2538)  
**Kit 2514** • Pulley Block 20,000 lbs. (2220)  
• Nylon Sling (1509)  
**Kit 1554** • Pulley Block 7,000 lbs. (2227)  
• Nylon Sling (1509)

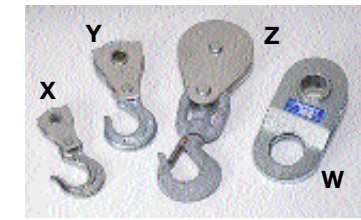

**X 2227** Pulley Block 7,000 lbs. For EX1, X1, and S2500  
**Y 2229** Pulley Block 9,000 lbs. For S4500 (not for Husky, X9, or S9000)  
**Z 1795** Swivel Pulley Block 4,000 lbs.  
**W 2223** Heavy Duty Pulley Block 20,000 lbs. For X9, X9000 and Husky  
**2220A** Heavy Duty Pulley Block with hook 20,000 lbs. (not shown)

## Recovery Straps, Tie Downs



**A - Recovery Straps**  
**2517** 2"x20' 20,000 lbs.  
**2518** 2"x30' 20,000 lbs.  
**2519** 3"x30' 30,000 lbs.  
**2520** 4"x30' 40,000 lbs.  
**2521** 6"x30' 60,000 lbs.

**Tie Downs**  
**2522** Race Car Tie Down  
**1586** Axle Straps  
**1587** Wheel Tie Downs  
**2525** Ratchet Tie Down 1" x 14' 1,800 lbs.

**Tree Trunk Savers (Not Shown)**  
**1509** 2"x6' 20,000 lbs.  
**2531** 3"x8' 30,000 lbs.  
**2516** Emergency Tow Strap 1 3/4" x 15', 20,000 lbs.

# Product Guide 1998